

# Savi 7210/7220 Office for desk phone

# Contents

DECT information	<b>3</b>
DECT Enhanced security	<b>3</b>
Overview	<b>4</b>
Headset overview	<b>4</b>
Base overview	<b>5</b>
Accessories	<b>6</b>
Hook up system	<b>7</b>
Desk phone setup details	<b>7</b>
Subscribe headset to base	<b>10</b>
Automatic secure subscription	<b>10</b>
Manual over-the-air subscription	<b>10</b>
Ending subscription	<b>10</b>
Fit and charge	<b>11</b>
Wear on the right or left	<b>11</b>
Charge your headset	<b>11</b>
Battery	<b>11</b>
System basics	<b>12</b>
Power on your headset	<b>12</b>
Adjust volume	<b>12</b>
Make, answer, end calls	<b>12</b>
More Features	<b>14</b>
Out of range warning tones	<b>14</b>
Talk time	<b>14</b>
Wideband/narrowband audio switch	<b>14</b>
Troubleshooting	<b>15</b>
Headset	<b>15</b>
Desk phone	<b>16</b>
Support	<b>17</b>

# DECT information

**DECT products should never be used outside the region in which they were originally purchased and intended to be used.**

The enclosed DECT wireless product uses restricted wireless radio frequencies which vary by country. Use of this DECT product in unauthorised countries is a violation of law, may disrupt telecommunications networks and devices and can subject you to fines and penalties by regulatory agencies.

## DECT Enhanced security

Plantronics is a member of the DECT Forum and has fully adopted their recommendations for enhancements to security within all DECT products.

Plantronics DECT-based products now fully incorporate the latest recommendations on Enhanced security from the DECT Forum and ETSI. These improvements cover registration, authentication, authorisation and encryption procedures. Plantronics DECT products are now secure against all the known vulnerabilities that were highlighted by the public announcements of the Chaos Council in 2009.

Plantronics DECT products have been tested against and passed the DECT Forum security certification requirements and consequently have been granted 'DECT Forum security' logo certification.







Plantronics products using the new enhanced version of DECT that includes these security improvements are marked on the base with the DECT Forum security logo.

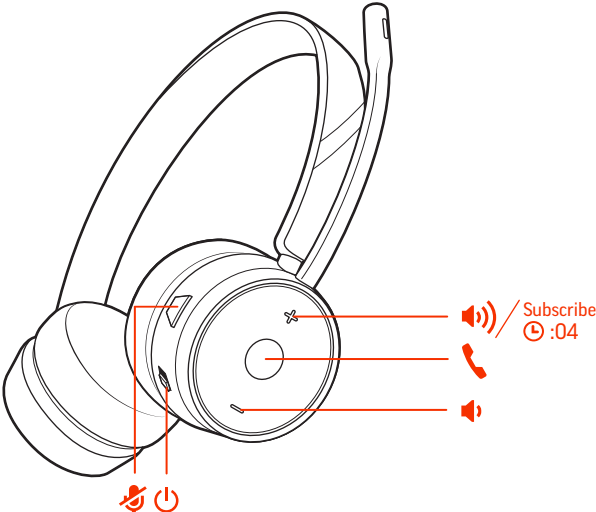

# Overview

## Headset overview



	Mute/unmute
	Power
	Manual subscribe (connect)
	Volume up
	Volume down
	Call

**Be safe**  
Please read the safety guide for important safety, charging, battery and regulatory information before using your new headset.

Base overview

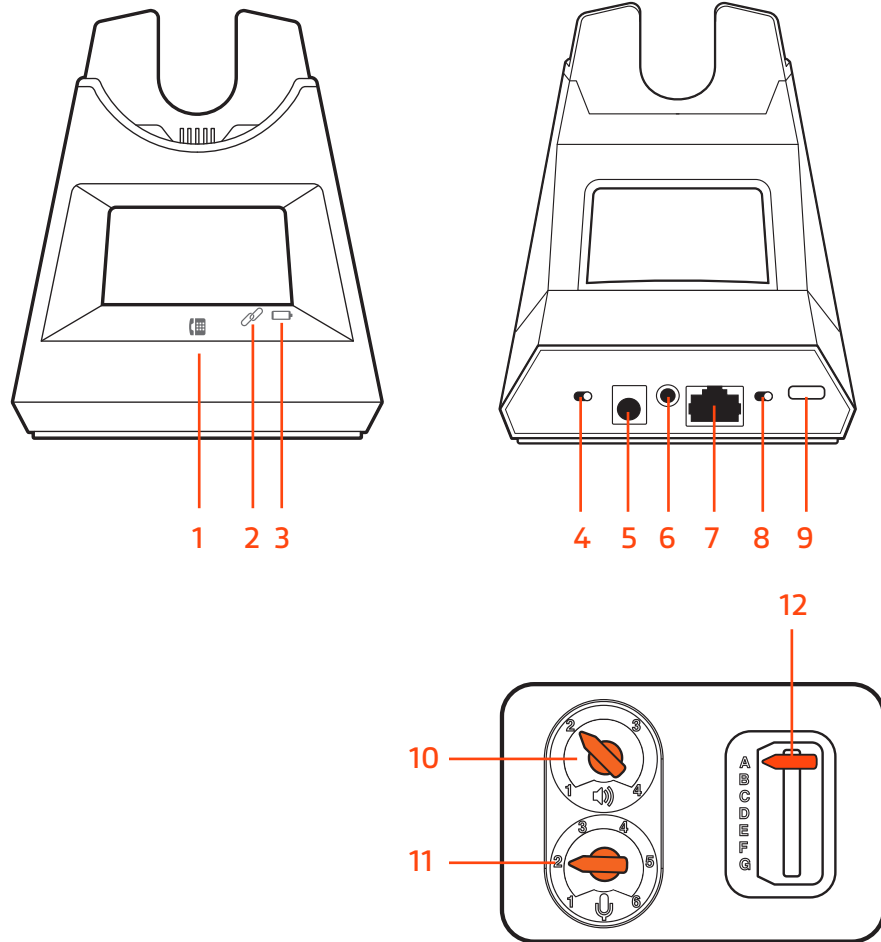

- 1 Desk phone LED
- 2 Subscribe LED
- 3 Charging LED
- 4 Wideband/narrowband audio switch
- 5 Power jack
- 6 Handset lifter jack

- 7 Telephone interface cable jack
- 8 Auto answer
- 9 Subscription button
- 10 Desk phone listening volume
- 11 Desk phone speaking volume
- 12 Desk phone configuration switch

## Accessories

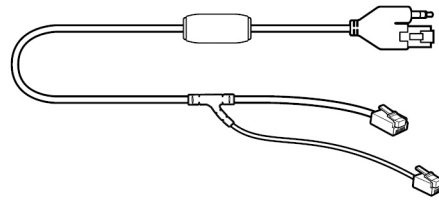

1



2

- 1 Electronic hookswitch cable (EHS cable)** Electronically and automatically answers/ends a desk phone call. Enables remote call control with your headset.
- 2 HL10 lifter** Automatically lifts handset and returns it to the cradle. Enables remote call control with your headset.

# Hook up system

Using the diagram, connect your headset system.

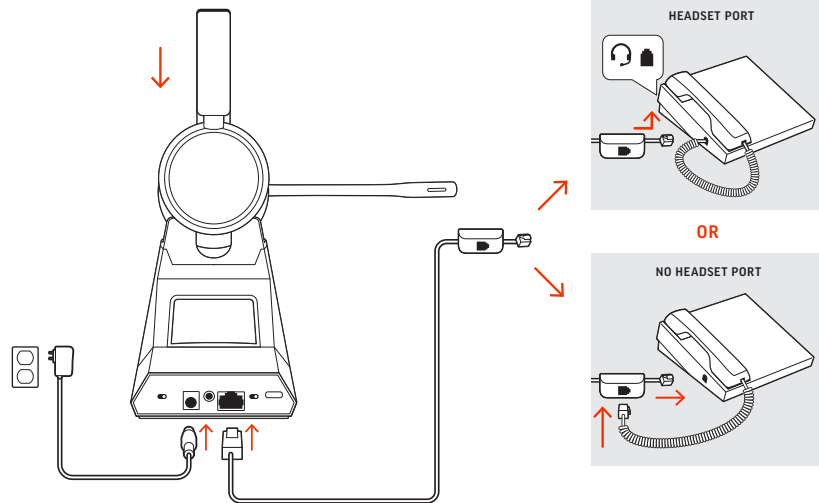

**NOTE** Base configuration settings

Desk phone	Setting (on bottom of base)
Most phones	A
Cisco phones	D
Cisco phones with EHS cable	A

## Desk phone setup details

Choose a desk phone setup A, B, C or D and connect cables.

### A Desk phone with dedicated headset port

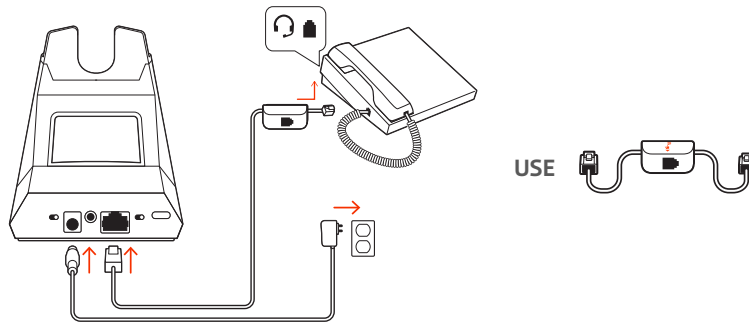

- Connect one end of the telephone interface cable to the back of the base
- Connect the other end of the telephone interface cable into the dedicated headset port on the desk phone

**IMPORTANT** Cisco phones use configuration D on the bottom of the base. Most other phones use default configuration A.

**NOTE** Use this setup if you are not using the HL10 lifter or EHS cable. In this configuration, press both the headset button on your desk phone and the call control button on the headset to answer or end calls.

## B Desk phone (standard)

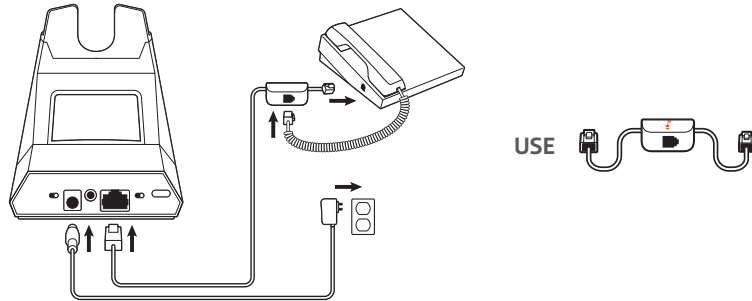

- Connect one end of the telephone interface cable to the back of the base
- Disconnect the handset coil cord from the base of the desk phone and re-connect it to the telephone interface cable junction box
- Finally connect the remaining end of the telephone interface cable into the open handset port on the desk phone

**IMPORTANT** Cisco phones use configuration **D** on the bottom of the base. Most other phones use default configuration **A**.

**NOTE** Use this setup if you are not using the HL10 lifter or EHS cable and your desk phone does not have a dedicated headset port. In this configuration, manually remove the handset on your desk phone and press the call control button on the headset to answer or end calls.

## C Desk phone + EHS cable (sold separately)

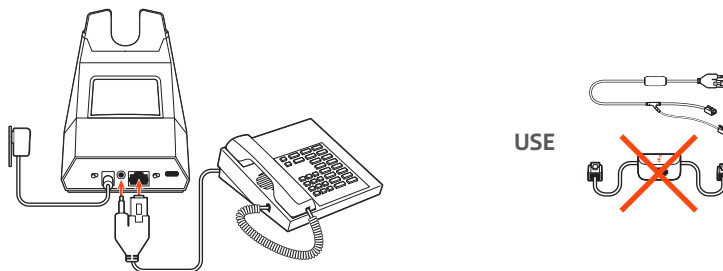

**IMPORTANT** Use configuration **A** on the bottom of the base, which works for most phones including Cisco phones.

## D Desk phone + HL10 lifter (sold separately)



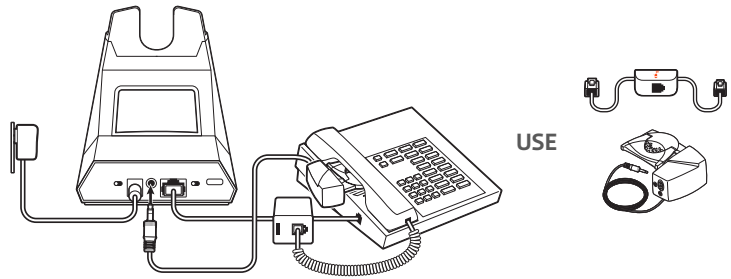

**IMPORTANT** *Cisco phones use configuration D on the bottom of the base. Most other phones use the default configuration A.*

# Subscribe headset to base

The headset and base that came in the box are subscribed (connected) to each other. However, if you wish to use a new headset or need to restore subscription to your current headset, the units can be subscribed to each other by the following two methods.

## Automatic secure subscription

With your system idle, docking a headset will automatically subscribe it to the base, making it the primary headset. The base subscription LED will flash during the subscription process and becomes solid green when the new subscription is established.

## Manual over-the-air subscription

- 1 With your system idle and your headset undocked, press and hold the Subscription button on the back of the base for 4 seconds. The subscription LED on the display panel will flash.
- 2 Press and hold the Volume up button on the headset for 4 seconds until the headset LED turns solid green.
- 3 When the base subscription LED turns solid green and the headset LED turns off, the headset and base are subscribed to one another.

**NOTE** *If the subscription process times out after 2 minutes or if the subscription process fails, try to re-subscribe the headset again.*

## Ending subscription

If the base is in subscription mode and you want to stop the base from searching for a headset, press the subscription button again or place the headset in the charging cradle. The subscription LED on the base stops flashing and is solid green.

# Fit and charge

## Wear on the right or left

To position the microphone on the right or left side, rotate the microphone boom up and over. Gently bend the boom so it is approximately 2 finger widths from the corner of your mouth.

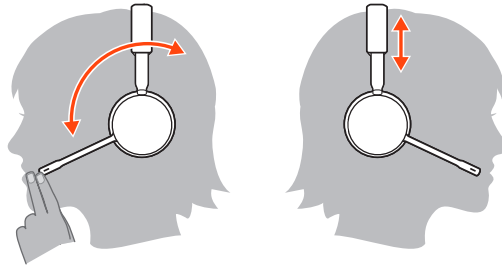

## Charge your headset

Place the headset in the charging cradle. The charging LED flashes when charging the headset and remains steady when the headset is fully charged. Charge for at least 20 minutes prior to the first use.

## Battery

This product has a replaceable battery. To ensure replacement batteries meet Plantronics high quality standards and for optimal performance, only use replacement batteries provided by Plantronics.

### Low battery warning

If you are on a call and the headset battery is critically low, you will hear a repeated single low tone every 15 seconds indicating that the battery is low. You should recharge the headset immediately or swap the low battery for a fully-charged battery.



If you are not on a call and press the call button, you will hear three low tones if the battery is critically low. You should recharge the headset immediately or swap the low battery for a fully-charged battery.

# System basics

## Power on your headset

To turn on the headset, slide the Power  button.

## Adjust volume

- **Headset volume** Fine-tune your headset volume by adjusting the headset's volume up (+) and down (-) controls.
- **Desk phone volume** When you are on a call and your voice is too quiet/loud, adjust the speaking  volume on the bottom of the base. If your caller's voice is too loud/quiet on a desk phone call, adjust the listening  volume.

## Make, answer, end calls

### Make a call (deskphone)

- 1 Tap the headset call button. The desk phone  icon lights up on your base display. You should hear a dial tone in your headset.

**NOTE** Press your phone's Headset  button or manually remove the handset if you don't have an HL10 lifter or EHS cable.

**TIP** If you do not hear a dial tone, turn over the base and adjust the switch (A--G). "A" works for the majority of desk phones. "D" works for Cisco phones.

- 2 Dial from your desk phone.

### End/take a call

To answer or end a call, tap the headset Call button.

**NOTE** If you don't have an HL10 lifter or EHS cable, press your phone's Headset  button or remove the handset when answering a call and hang up when ending a call.

### Auto answer

Auto Answer automatically answers a call by lifting the headset from the base and ends a call when replacing the headset in the cradle. Slide the Auto Answer switch to the right to activate.

**NOTE** Auto answer/end capability requires an EHS cable or HL10 lifter.

### Mute a call

Tap the Mute button to mute a call, you hear 3 quick tones. The corresponding base icon turns red. Tap again to unmute.

### Hold a call

To hold an active call, press the Volume Up or Down button for 4 seconds. Press the Call button to resume a held call.

### Switch between calls (flash)

To switch between calls, press the Volume Up or Down button for 4 seconds.

### Set up a conference call

You can conference up to 3 additional headsets to a call in progress.

#### Join Savi headsets automatically (same headset type only)

- 1 While on a call, place the guest headset into the primary user's charging cradle. The base subscription LED flashes.
- 2 The primary user hears a triple tone in their headset indicating a conference request. To accept the request, press the primary user's headset Call button within 10 seconds.
- 3 If the process fails or times out because the guest's Call button is not pressed within 10 seconds, the guest subscription is terminated and the guest hears an error tone.

#### Join Savi headsets manually

- 1 While on a call, press the primary user's base subscription button. The base subscription LED flashes.

- 2 Hold the guest headset's Volume up until the headset LED turns on.
- 3 The primary user hears a triple tone indicating a conference request. To accept the request, press the primary user's headset Call button within 10 seconds.
- 4 If the process fails or times out because the guest's Call button is not pressed within 10 seconds, the guest subscription is terminated and the guest hears an error tone.

**NOTE** *Headsets in a conference have independent mute controls. The base only indicates the primary user's mute state.*

#### **Exit a conference call**

- 1 Guest headsets can remain as guests through multiple calls. To remove a guest headset, press the guest headset's Call button or dock the primary user's headset in the charging cradle. The primary user hears a single tone in their headset as each guest leaves the call.

**NOTE** *The primary user may hear additional tones in their headset and see the base subscription LED flash as guest headsets join the call. These indicate that a guest headset has a different firmware version than the primary headset, but can still be used for conferencing.*

# More Features

## Out of range warning tones

If you are on a call and go out of the operating range, you will hear three low tones. You will hear a single mid tone when you are back in range.

If you stay out of range, active calls will be suspended. Calls will be re-established when you walk back into range. If you remain out of range for more than 5 minutes, the system will drop the call.

If you are not on a call and go out of the operating range and press the call button, you will hear a single tone for the button press and three low tones for the failure to make a link.

## Talk time

With a full charge, the headset provides up to 13 hours of talk time in narrowband mode.

## Wideband/narrowband audio switch

Your headset system has wideband audio, which allows speech to sound clearer and more natural. If your desk phone is capable of wideband audio, slide the Wideband-Narrowband switch  to the right for wideband mode.

**NOTE** *Talk time will be reduced when operating in wideband mode.*

Slide the switch  to the left for narrowband for longer headset battery life or to increase the number of systems that can work in a small area.

# Troubleshooting

## Headset

---

I can't hear a dial tone in the headset.

- Make sure your headset is charged.
- Make sure your headset is subscribed to base. See [Subscribe headset to base](#).
- Adjust the configuration switch (A--G) on the bottom of the base until a dial tone is heard. The default **A** works for most phones. **ATTENTION** Use configuration **D** for Cisco phones. Cisco phones connected with an EHS cable use configuration **A**.
- Make sure your desk phone is connected correctly to your base. See [Desk phone setup details](#).
- If your base is connected to your desk phone's dedicated headset port, press the desk phone's headset button to hear a dial tone.
- If your base is connected to your desk phone's dedicated headset port, press the desk phone's headset button and base's desk phone button to hear a dial tone.
- If your base is connected to your handset port, manually remove the handset to hear a dial tone (if you do not have an EHS cable or HL10 lifter).
- Make sure your HL10 lifter is lifting the handset high enough to operate the hookswitch; set to a higher setting if necessary.
- Adjust the headset's listening volume. See [Adjust volume](#).
- If the volume is still too low, adjust the desk phone listening volume on the base. See [Adjust volume](#).

---

I hear static.

- Make sure there are at least 12 inches between your base and your computer, and 6 inches between your base and your telephone. If adjusting the distance doesn't help, your headset is going out of range; move closer to the base. See [Position Your Base](#).

---

The sound is distorted.

- Lower the desk phone speaking volume and/or desk phone listening volume on the base. For most telephones, the correct setting is position 2. See [Adjust volume](#).
- If your desk phone has a volume control, lower until the distortion disappears.
- If the distortion is still present, adjust the headset volume control to lower the headset speaker volume. See [Adjust volume](#).
- Make sure there are 12 inches between your base and your computer, and 6 inches between your base and your telephone. See [Position your base](#).

---

I hear echo in the headset.

- Lower the desk phone speaking volume and/or desk phone listening volume on the base. For most telephones, the correct setting is position 2. See [Adjust volume](#).
- If the audio level is too low in this position, increase the headset volume. See [Adjust volume](#).
- If your speaking volume is too low for your listener in this position, adjust the position of the headset to make sure the microphone is as close as possible to your mouth.

People I talk to can hear a buzz in the background.

- Move the base further away from your phone. See Position your base.
  - If the base power supply is plugged into a power strip, plug it into the wall directly.
- 

## Desk phone

The handset lifter is installed but does not lift the handset.

- Ensure the handset lifter power cord is firmly pushed into the handset lifter jack on the base.
-



# Support

## NEED MORE HELP?

[plantronics.com/support](https://plantronics.com/support)

**Plantronics, Inc.**

345 Encinal Street  
Santa Cruz, CA 95060  
United States

**Plantronics B.V.**

Scorpius 171  
2132 LR Hoofddorp  
Netherlands

© 2020 Plantronics, Inc. All rights reserved. Poly, the propeller design, and the Poly logo are trademarks of Plantronics, Inc. DECT is a trademark of ETSI. All other trademarks are the property of their respective owners. Manufactured by Plantronics, Inc.

215231-07 01.20